

802.11b/g Wireless LAN Module / Device Server

TCP/IP (BISM II Pin Compatible)

Part Number: WISMC01BI

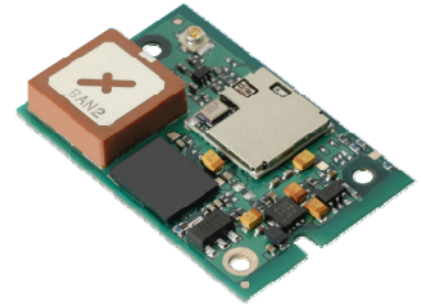

1. General Description

The EZURiO 802.11b/g TCP/IP Wireless LAN Module is a fully integrated and qualified wireless device server, designed to make it simple to embed 802.11 connectivity. Unlike other wireless modules all of the necessary drivers, protocol stack, security algorithms and antenna are integrated. The module also includes an interpreter that can run scripts, providing a complete wireless processing solution. It enables you to add wireless internet connectivity to almost any device with a serial port. The module is designed for lowest cost of integration and ownership. It is ideal for enabling M2M applications.

The module is a dual processor design, dedicating one processor to the 802.11b/g baseband with a second powerful ARM7 processor, with 16MB of SRAM and 64MB of flash memory running the wireless drivers, TCP/IP stack, web server and UWScript interpreter. Connection to the host device is via a high speed 921,600 bps UART, with an additional twelve GPIO lines and two 10 bit ADCs. The interpreter allows complex scripts to be run, allowing the WISM module to operate with zero host loading. It means it is possible to use the module to wirelessly enable "dumb" sensors or UART ports.

The UWScripting wireless language developed by EZURiO is simple to use, but provides a rich programming environment. Derived from BASIC, it allows powerful scripts to be written that combine WLAN link management with TCP/IP socket control and machine interaction. A wide range of example scripts are available which allow new applications to be rapidly developed. Scripts are downloaded into the module via the UART and then either run under control from the host processor or autonomously at power on.

The use of a scripting language allows the module to function in a wide variety of applications, from simple cable replacement, to a more complex communications co-processor in which the module takes over the management of the communications interface, or as a completely self-contained M2M solution in which the module gathers information and reports it without host intervention.

An HTTP server is built into the module which allows user defined web pages to be served using dynamic web page content supplied from a script. Information for the web page can be taken from the UART stream, any of the GPIO or ADC pins, or variables within the script. The use of scripts allows these to be pre-processed before being displayed on the web page. Similarly, information can be sent to the script running on the module using HTTP POST commands. This allows flexible user interaction with a module via a standard web browser. With the addition of an appropriate script it allows the implementation of complete web enabled controllers and monitoring devices.

The twelve GPIO and two analogue input lines can be configured using scripts to provide control or monitoring of simple devices such as switches or LEDs without requiring any external processing. Both the GPIO and ADC lines can be accessed using scripts over either the wired host UART connection, or remotely over the Wireless LAN connection.

The module includes a high sensitivity, high gain antenna which provides excellent range. Typical open field performance yields an operating range of over 100 metres. A second 50 Ohm U.FL connection is provided for an external antenna. This can be used in place of the internal antenna, or in conjunction with the internal antenna to implement antenna diversity for improved receive performance.

Support is provided for low power modes that make the Wireless LAN module particularly applicable to battery powered installations. It has been designed to ensure the best co-existence with other devices operating within the same frequency spectrum and has hardware support designed into the module for 2 and 3-wire Bluetooth co-existence schemes. Direct connectivity to the EZURiO BISM Bluetooth module is supported, as well as to other enabled Bluetooth devices.

The Wireless LAN module is supplied in a small pcb form factor (22.8mm x 33.8mm x 7.6mm), that connects to a main pcb using a 40 way Hirose connector which is pin compatible with the EZURiO Bluetooth Intelligent Serial Module BISMII. The module is Lead-free and RoHS compliant and supports an industrial operational temperature range of -40°C to +85°C.

The module has FCC modular certification, Industry Canada certification and CE approval. These approvals allow users to simplify or bypass RF regulatory testing, enhancing time to market and reducing approvals time and cost.

A low cost development system is available for fast product evaluation and development.

Applications

- POS Equipment
- Medical Equipment
- Telematics
- Metering Applications
- Automotive Applications
- Street furniture
- Industrial Automation

2. Features

Feature	Implementation
Wireless Specification	
Standards Supported	IEEE 802.11b, IEEE 802.11g
Frequency	2.412 – 2.484 GHz
Channels	11 channels – USA 13 channels – Europe 4 channels – France (EIRP > 10mW outdoors) 14 channels – Japan <i>Programmable selection of region</i>
Max Transmit Power	802.11b: +15 dBm @ antenna connector 802.11b: +17 dBm from integrated antenna 802.11g: +13 dBm @ antenna connector 802.11g: +15 dBm from integrated antenna
Receive Sensitivity	802.11b: -91dBm @ 1 Mbps, -84dBm @ 11Mbps 802.11g: -84dBm @ 6Mbps, -67dBm @ 54Mbps
Data Rates	54Mbps – 1Mbps with automatic fallback
Data Transfer rate	Up to 921.6kbps (limited by UART)
Modulation Schemes	802.11b – BPSK, QPSK, CCK, DSSS 802.11g – BPSK, QPSK, 16-QAM, 64-QAM, OFDM
Range	Up to 100 metres free space
Connection Modes	Infrastructure and ad-hoc (IBSS)
Antenna Modes	
Integrated Antenna	High performance +2dBi multilayer ceramic
External Antenna	50 Ohm U.FL connection
Antenna Diversity	Supported using integrated and external antennae
UART Interface	
Serial Interface	RS-232 bi-directional for commands and data 16550 compatible
Baud Rate	Configurable from 9,600 to 921,600bps
Bits	7 or 8
Parity	Odd, even, none
Stop bits	1 or 2
Default Serial parameters	115200,n,8,1
Levels	3.0V CMOS
Modem Control	DTR, DSR, DCD, RI, RTS, CTS †
General Purpose Interface	
I/O	12 general purpose I/O pins, 3.0V CMOS†
ADC	2 ADC inputs. 10 bit, 3.0V max

†DSR, DTR, RI and DCD are configurable either as GPIO or as modem control lines.

Security

Open Connection
WEP encryption 64 and 128 bit options
WPA-PSK
WPA2 Enterprise & Personal
IEEE 802.11i-PSK (AES-CCMP)
TKIP Encryption
SSL2 / SSL3 / TLS1*
Hardware Acceleration for security features

Protocols

Network Drivers 802.11b, 802.11g
Internet IPv4, TCP, UDP, DHCP Client, DNS Client, ARP, HTTP Server
Other protocols are supported via UWScript, e.g. Telnet

Web Server

Features Serves web pages from the module
Runs standard user generated HTTP web pages
Provides access to I/O and ADC status
Serves Dynamic Content from UWScripts
Accepts POST inputs for control of scripts
Allows dynamic control of ports
Website Capacity 128kBytes **

Power Consumption

Powersave modes IEEE Powersave Modes 0,1,5 & 6
Current Consumption Less than 250mA during data transfer with a configurable low power mode less than 5mA

Supply Voltage

Supply 3.3V – 5.0V DC
Regulation On-board regulators, brown-out detection and watchdog

Embedded Wireless Processor System

Specification ARM7 with 16Mb SRAM and 64Mb Flash
Scripting Interpreter Runs UWScript
Fully featured scripting language with wireless extensions
Data Filing System User accessible
Script Capacity 128kBytes **
Auto-run Optional Automatic script execution at power on
WLAN functions Search, Attach, Detach, Security, Region, etc.
Upgradeability Firmware upgradeable via UART

Coexistence / Compatibility

Bluetooth 2-wire and 3-wire hardware coexistence schemes supported
Pin compatible with EZURiO BISM Bluetooth modules

Connections

Interface 40 way Hirose DF-12 Connector
External Antenna U.FL connector for 50 Ohm antenna

* Available Q1 2008

** Shared memory space for scripts and web content

Physical

Dimensions	22.8mm x 33.8mm x 7.6mm
Weight	8 grams

Environmental

Operating Temperature	Low Power Mode: -40°C to +85°C
	Continuous transmission: -40°C to +60°C
	Minimum cold start temperature: -25°C
Storage Temperature	-50°C to +125°C

Approvals

FCC	Modular Approval PI405W
IC	Industry Canada
CE & R&TTE	Approved

Miscellaneous

Lead free	Lead-free and RoHS compliant
Warranty	2 Years

Development Tools

Development Kit	Development board and software tools
UWTerminal	Free downloadable terminal emulator
UWScript Library	Free example scripts for a wide range of applications

3. Block Diagram

The module has a 40 way Hirose connector which provides a compatible pin out to the same form factor EZURiO Bluetooth Intelligent Serial Module.

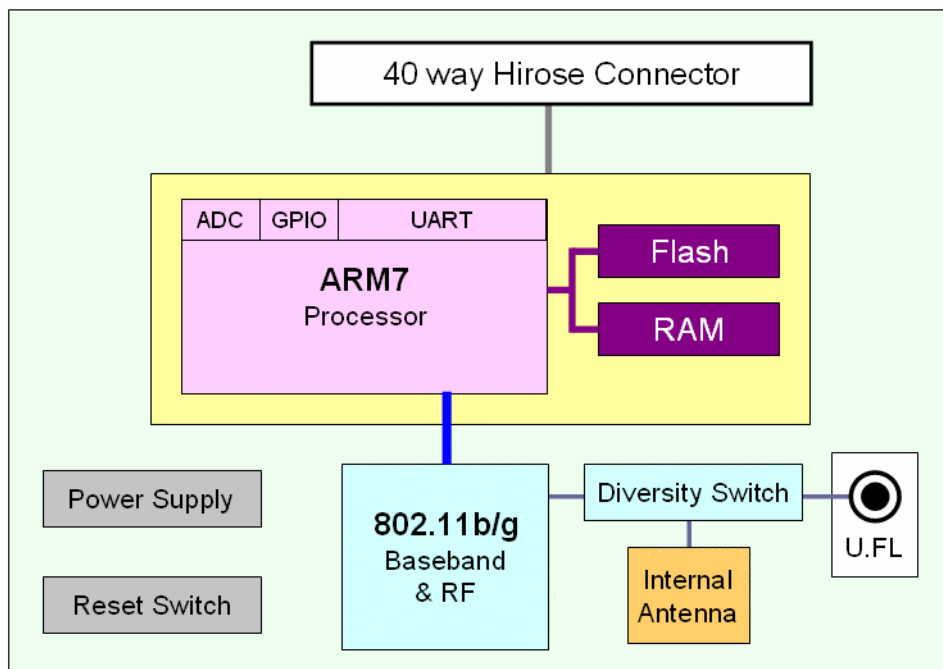

4. Mechanical

4.1 Wireless LAN Module Dimensional outline

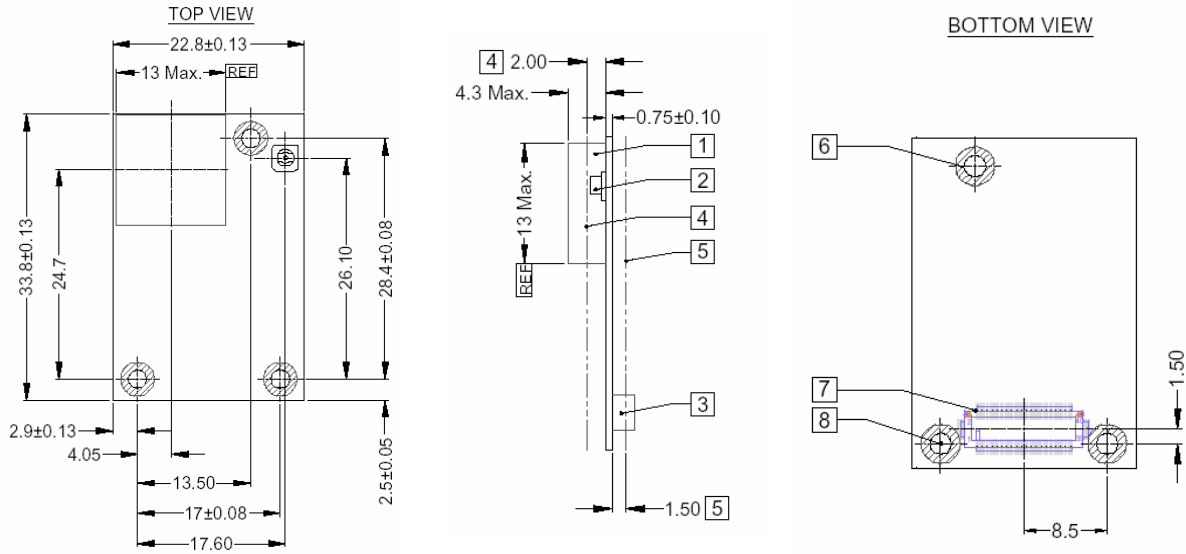

All dimensions in mm

Notes	
1	RF antenna
2	External Antenna connector (Hirose U.FL-R-SMT)
3	Board to board connector (Hirose connector)
4	2.0mm maximum top side component height (excluding antenna)
5	1.5mm maximum bottom side component height
6	3.8mm max. pcb clearance for fixings body (top and bottom)
7	40 way connector footprint
8	2.2 +/- 0.075 fixing holes x 3

The Module is equipped with a 40-pin 0.5mm pitch board-to-board connector that connects to the application platform.

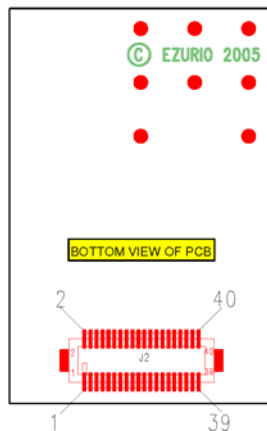

5. Electrical

5.1 40 way Hirose Pin Descriptions

The Hirose DF12C board-to-board connector on the module is a 40-pin double-row receptacle.

The table below defines the pin functions. The pin-out is as viewed from the underside of the Module.

Pin No.	Signal	Description
1	ADC 0	3.0 V Max
3	ADC 1	3.0 V Max
5	WLAN_ACTIVE	Output
7	N/C	
9	N/C	
11	GND	
13	RESET	Reset Input
15	GND	
17	N/C	
19	UART_CTS	Clear to Send Input
21	UART_TX	Transmit Data Output
23	UART_RTS	Request to Send Output
25	UART_RX	Receive Data Input
27	VCC_3V	3.0V Monitor
29	VCC_5V	Supply
31	VCC_5V	Supply
33	GPIO6	I/O for Host
35	GPIO7	I/O for Host
37	GPIO8	I/O for Host
39	GPIO9	I/O for Host

Pin No.	Signal	Description
2	GPIO1	I/O for Host.
4	GPIO2	I/O for Host
6	UART_RI	Ring or GPIO12
8	UART_DCD	DCD or GPIO13
10	UART_DSR	DSR or GPIO10
12	UART_DTR	DTR or GPIO11
14	GPIO4	I/O for Host
16	GPIO5	I/O for Host
18	GND	
20	N/C	
22	WAKEUP	Reserved
24	BT_PRIORITY	Input
26	N/C	
28	VCC_5V	Supply
30	GND	
32	N/C	
34	N/C	
36	GND	
38	GND	
40	BT_STATE	Input

Notes:

The reset circuitry within the module incorporates a brown-out detector. The reset pin has a fixed 10kOhm pull down resistor to ground, followed by a 10kOhm resistor feeding the base of a transistor.

GPIO lines can be configured through software to be either inputs or outputs. At reset, all GPIO lines are configured as inputs.

UART_RX, UART_TX, UART_CTS, UART_RTS, UART_RI, UART_DCD, UART_DTR and UART_DSR are all 3.0v level logic. When the signal sits at 3.0V it is de-asserted. When the signal is at 0V it is asserted.

UART_RX, UART_TX, UART_CTS, UART_RTS are controlled directly by the module. The operation of UART_RI, UART_DCD and UART_DTR is user programmable under script control.

Pin 27 (VCC_3V) may only be used for monitoring purposes. It must not be used as a current source.

Pin 22 (WAKEUP) will be used for future powersave functionality. It has an internal 100kOhm pull-up.

ADC inputs (pins 1 and 3) are read using UWscript functions.

UART_DSR is used to enable autorun. After power-up it can be used as GPIO. See Section 8.2.

Pins marked N/C may have internal connections within the module and should not be connected to any external circuitry.

5.2 Electrical Specifications

5.2.1 Absolute Maximum ratings

Absolute maximum ratings for supply voltage and voltages on digital and analogue pins of the Module are listed below. Exceeding these values will cause permanent damage.

Parameter	Min	Max	Unit
Peak current of power supply		550	mA
Voltage at digital pins	-0.3	3.3	V
Voltage at VCC_5V pin	3.3	5	V

5.2.2 Recommended Operating Parameters

5.2.2.1 Power Supply

Signal Name	Pin No	Voltage level	Comments
VCC_5V	28, 29, 31	3.3V to 5.0V	$I_{typ} = 250mA$. All VCC_5V pins should be connected
GND	11,15,18,30,36,38		All six GND pins should be connected

5.2.2.2 Signal Levels for Interface and GPIO

Signal Type	Signal level	Signal level @ 0mA load	Signal level @ 4mA load
Input	$V_{ILmax}=0.8V$ $V_{IHmin}=2.1V$ $V_{IHmax}=3.3V$		
Output		$V_{OLmax}=0.2V$ $V_{OHmin}=2.8V$	$V_{OLmax}=0.4V$ $V_{OHmin}=2.6V$

5.2.2.3 RS-232 Interface

Signal Name	Pin No	I/O	Comments
UART_TX	21	O	This pin must NOT be pulled low by external circuitry.
UART_RX	25	I	
UART_CTS	19	I	
UART_RTS	23	O	
UART_DSR	10	I	Used to enable autorun at power up – programmable by script
UART_DTR	12	O	Direction is programmable – default is Output
UART_RI	6	O	Direction is programmable – default is Output
UART_DCD	8	O	Direction is programmable – default is Output

5.2.2.4 General Purpose I/O and ADC

Signal Name	Pin No	I/O	Comments
GPIO 1 - 9	2,4,14,16,33,35,37, 39	I or O	There is no GPIO3
GPIO 10 – 13	10,12,6,8	I or O	Shared with DSR, DTR, RI, DCD
WAKEUP	22	I	Reserved
ADC0, ADC1	1, 3	I	Range 0 – 3.0V

5.2.2.5 Other Functions

Signal Name	Pin No	I/O	Comments
RESET	13	I	Active high. The RESET line has a fixed 10kOhm pull down resistor to ground, followed by a 10kOhm resistor feeding the base of a transistor.
3VOUT	27	O	Used to monitor the state of the regulated supply within the module. THIS PIN MUST NOT BE USED TO POWER AN EXTERNAL CIRCUIT.

5.2.2.6 Signal Levels for Bluetooth Coexistence and Wakeup Pins

Signal Type	Signal level
Input	$V_{ILmax}=1.0V$ $V_{IHmin}=1.5V$ $V_{IHmax}=3.5V$
Output	$V_{OLmax}=0.4V$ $V_{OHmin}=2.4V$

5.2.2.7 Bluetooth Coexistence

Signal Name	Pin No	I/O	Comments
WLAN_ACTIVE	5	O	
BT_PRIORITY	24	I	If unused, this pin should be pulled low.
BT_STATE	40	I	If unused, this pin should be pulled low.

5.2.2.8 Wakeup

Signal Name	Pin No	I/O	Comments
WAKEUP	22	I	Reserved for future use. The WAKEUP line has a fixed 100kOhm pull-up resistor.

6. RF Performance

6.1.1 Transmit Power (802.11g)

Conducted Transmit Power	Typ: +13 dBm
Antenna Gain (Integrated Antenna)	+2dBi typ.
Effective Transmit Power	Typ: +15dBmi

6.1.2 Transmit Power (802.11b)

Conducted Transmit Power	Typ: +15 dBm
Antenna Gain (Integrated Antenna)	+2dBi typ.
Effective Transmit Power	Typ: +17dBmi

6.1.3 Receive Sensitivity (802.11b)

Receive Sensitivity (11Mbps)	Typ: -84dBm
Antenna Gain (Integrated Antenna)	+2dBi typ
Effective Receive Sensitivity	-86dBm

6.1.4 Receive Sensitivity (802.11g)

Receive Sensitivity (6Mbps)	Typ: -82dBm
Antenna Gain (Integrated Antenna)	+2dBi typ
Effective Receive Sensitivity	-84dBm

7. Functional Description

The Wireless LAN module is a self-contained product and requires only power to implement full communication. The integrated, high performance antenna together with the RF and baseband circuitry provides the Wireless LAN connectivity and the UART interface for a connection to a host system.

The complexity and flexibility of configuration are made simple for the design engineer by the integration of an extremely comprehensive scripting language - UWScript. UWScript provides a simple BASIC style language with a rich library of built-in functions that simplify connection of the module.

7.1 Interfaces

7.1.1 UART interface

Modem signal nomenclature can be a source of great confusion, particularly on devices which can be configured in either DCE (Data Communications Equipment) or DTE (Data Terminal Equipment) format. For the purpose of this data sheet all UART signals are defined on the assumption that the module is being used as a conventional DCE. I.e it is behaving like a serial PSTN modem.

UART_TX, UART_RX, UART_RTS and UART_CTS form a conventional asynchronous serial data port with handshaking, conforming to the ITU-T v.24 standard for DCE signalling. The interface is designed to operate correctly when connected to other UART devices such as a 16550A. Note that the signalling levels are a nominal 0V and 3.0V and are inverted with respect to the signalling on an RS232 cable. The interface is programmable over a variety of baud rates, with no, even or odd parity, one or two stop bits and hardware flow control. Non-standard baud rates are supported – for more information please contact EZURiO. Auto-bauding is not supported.

On power-up the UART defaults to 115200,n,8,1.

Note that there is no standardisation regarding the nomenclature of RX and TX across a DCE-DTE interface. Some implementations show TX(DCE) connected to TX(DTE) to give naming consistency across a cable, whereas other show TX driving RX to reflect logical port directions. Always check the direction of ports on DCE and DTE.

In a DCE mode, where the module is being driven as a peripheral by a host processor application, the UART signals should be connected according to the following scheme:

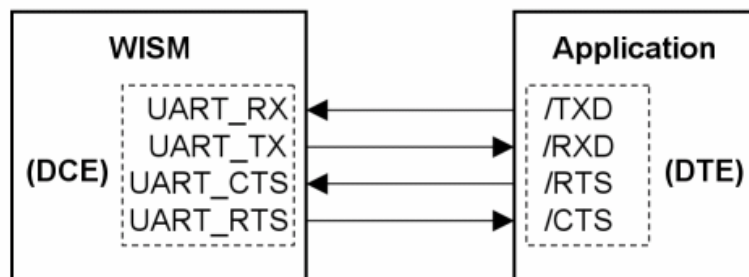

Port UART_TX **transmits** data to the application's /RXD input.

Port UART_RX **receives** data from the application's /TXD output.

Two-way hardware flow control is implemented by UART_RTS and UART_CTS. In DCE mode, UART_RTS is an OUTPUT and is active low. UART_CTS is an INPUT and is active low. These signals operate according to normal industry convention.

Some serial implementations link UART_CTS and UART_RTS to remove the need for handshaking. EZURiO does not recommend linking UART_CTS and UART_RTS other than for testing and prototyping. If these pins are linked and the host sends data at the point that the Wireless Module deasserts its UART_RTS signal, then there is a significant risk that internal receive buffers will overflow which could lead to a loss of data. EZURiO recommend that the correct UART_CTS to UART_RTS handshaking protocol be adhered to in order to ensure proper operation.

The UART_DSR signal is an input to the module and is used to control the operation of the autorun script. When the signal is de-asserted, the autorun script (if present) will be executed at power on. If the UART_DSR signal is asserted then the autorun script is ignored.

The operation, meaning and direction of the UART_RI and UART_DCD signals is user programmable under script control.

Note that the serial module output is at 3.0V CMOS logic levels. Level conversion must be added to interface with an RS-232 level compliant interface.

7.1.2 GPIO Port

Twelve lines of programmable bi-directional input/outputs (I/O) are provided that can be accessed either via the UART port or via the wireless link using UWscript functions. These can be used as data inputs or to control external equipment.

Each of the GPIO pins can be independently configured to be either an Input or Output. A selection of ports can be accessed synchronously.

Four of the lines (GPIO 10-13) are shared with modem control functions. If they are used to implement a fully featured UART, then they cannot be used for GPIO.

7.1.3 ADC

The Wireless LAN module provides access to two 10-bit ADCs. These provide an input range of 0V to 3.0v.

Suitable external scaling and over-voltage protection should be incorporated in your design.

7.1.4 Bluetooth Coexistence

Three pins are provided to allow implementation of Bluetooth coexistence schemes, when the 802.11 module is collocated with a Bluetooth radio. These connect directly between the basebands of the two radios to ensure minimum interference. Both 2-wire and 3-wire coexistence schemes can be supported.

Coexistence requires that the Bluetooth radio meets at least version 1.2 of the Bluetooth standard and supports Adaptive Frequency Hopping (AFH).

8. Firmware Features

8.1 Command Set

The Wireless LAN module has an integrated high level language called UWScript. UWScript provides both the command set and a structured programming language for the module. This language is described in detail in the UWScript Core Language and the UWScript Wireless LAN specific extension documents. Accompanying these are release notes specific to each module and firmware release, detailing the functions supported with each release.

8.2 Autorun

The interpreter in the WLAN module allows a script named autorun.uws to execute automatically at power on. This functionality is enabled using the UART_DSR input pin. When the signal is de-asserted, the autorun script will be executed at power on. If the UART_DSR signal is asserted then the autorun script is ignored. After power on the UART_DSR line can be reconfigured by scripts and used as GPIO10.

8.3 TCP/IP

The module includes a fully featured TCP/IP stack. The stack is RFC compliant for maximum interoperability and is designed specifically for the embedded environment. The stack fully supports UDP and TCP BSD sockets as well as providing underlying support infrastructure for the implementation of IP Security.

8.4 DHCP

With the Dynamic Host Configuration Protocol - DHCP - the process of configuring devices on a network gets automated. With very little administrator intervention it is easy to accommodate new devices to a network. Another big advantage of DHCP is that it allows for easy connection of mobile devices. DHCP-enabled modules can move from one place to another with no disturbances. The TCP/IP stack automatically gets an IP address and configuration suitable for the network segment it is currently attached to.

8.5 HTTP Server

The module provides an integrated HTTP server which is fully integrated with the UWScript environment allowing the user to rapidly develop web based solutions for machine reporting and control. User web pages can be written using any webpage generation tool and downloaded into the module. Dynamic web page content can be supplied from a script whilst control of the module and of any attached machines can be achieved using HTTP POST commands which are again processed using scripts.

8.6 Power Saving

The module supports the Wireless LAN IEEE power saving function. When this power saving mode is enabled, the wireless LAN chipset goes to sleep when it is not actively receiving from the access point. The chipset wakes up on a regular basis to receive broadcast messages from the AP or to transmit or receive unicast messages. By using this technique the average power consumption of the chipset is reduced from around 250mA in active receive mode to less than 35mA. The EZURiO module offers IEEE power save operation in three different modes:

- Powersave mode 1: The wireless LAN chipset operates in IEEE powersave mode and the module microcontroller remains fully awake and ready to receive commands and data from the host. This mode of power saving reduces the average consumption of the module to <35mA.
- Powersave mode 5: In this mode the module powers down the WLAN chipset, and awaits commands from the host or from a script running on the module. Since the WLAN module is powered down, the script cannot interact with the WLAN whilst in this mode. The average current consumption in this mode is reduced to <25mA.
- Powersave mode 6: In this mode the module powers down the WLAN chipset and places the microcontroller into a low power standby mode. Entry into powersave 6 is under script control. The module wakes up when a pre-defined PIO transition occurs. As the Wireless

LAN module is powered down, the same restrictions on script operation as powersave 5 apply. The average current consumption in this mode is reduced to <4mA.

Powersave mode 1 requires beacons to be broadcast from an infrastructure access point. Therefore it is not available when operating in ad-hoc (IBSS) mode.

9. Application Information

9.1 Antenna Location

The antenna used on the Wireless LAN module is designed to be largely immune from the effects of proximity detuning. Normally, antennas operating at 2.4GHz are affected by their surroundings, so that great care is needed in their placement and orientation.

The Wireless LAN module can be used in most locations and orientations and is only marginally affected by the presence of a significant ground plane in close proximity.

The antenna distribution is close to isotropic, which means that the orientation of mounting has only a limited effect on the overall range. However the optimum range is achieved when the two antennae are directly facing each other

9.1.1 Example of Radiation Characteristics

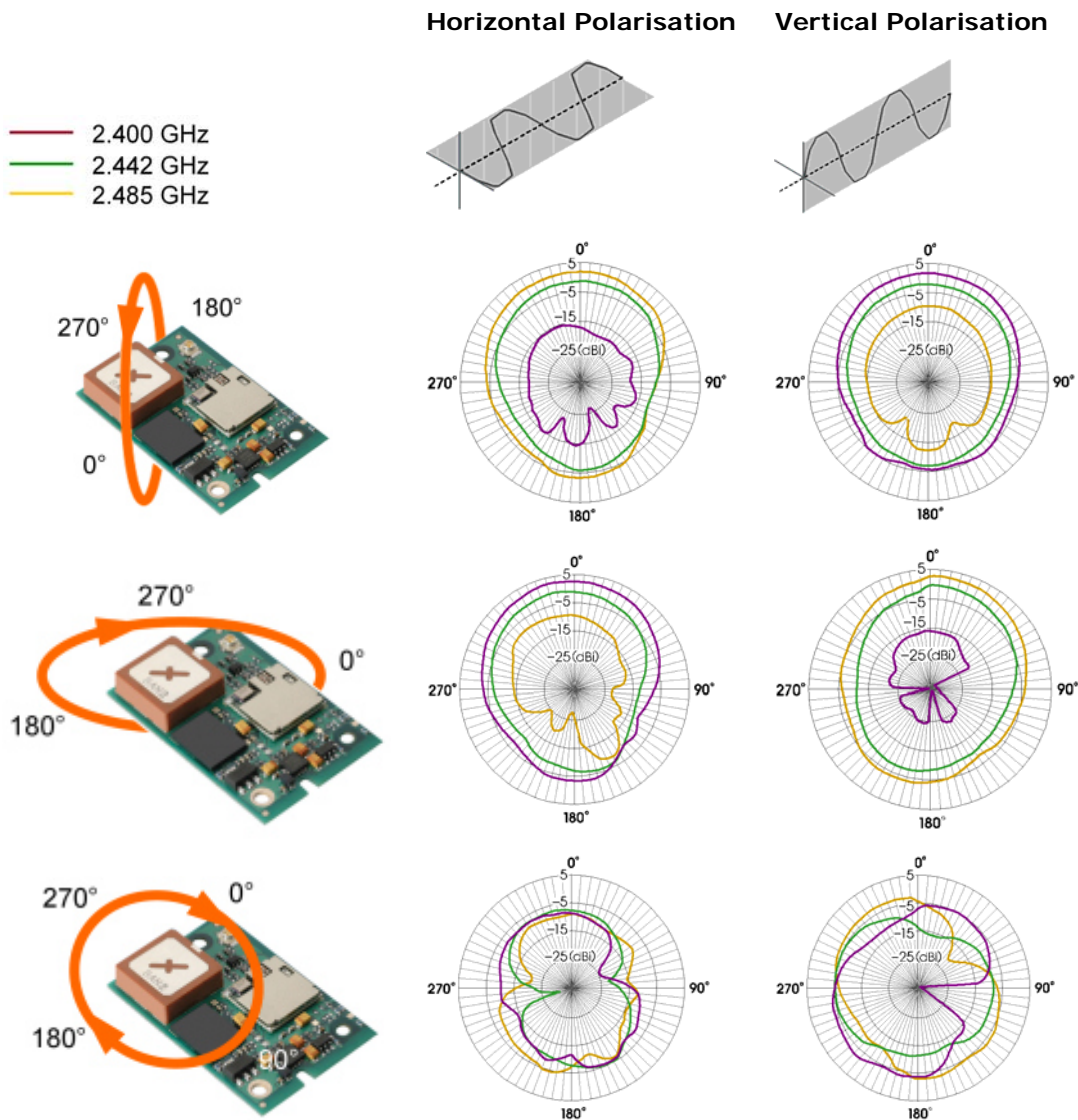

Typical Radiation Characteristics. Measured at 2.5 metres from a standard dipole.

The module should not be located in a sealed metal enclosure, as this will act as a Faraday cage and severely attenuate the radio signal.

The antenna finish may tarnish as a result of environmental conditions and handling. This is a cosmetic effect and does not affect the RF performance.

9.2 External Antenna

The approval of the module was performed using a 3dBi external antenna from RF Castle Electronics (www.rfcastle.com/pdf/RF-3dbi%20DipoleA.pdf). The antenna was connected using a short cable to convert from the U.FL connector on the module to a reverse SMA. The conditions of approval allow the use of an alternative antenna, but require that the resulting effective radiated power does not exceed that exhibited during the approvals testing.

To ensure that the approval is not affected, the TOTAL GAIN of the external antenna, including insertion loss of the connectors and cable must be less than 3dBi. If a higher gain is employed, then the pre-approved status of the module will be lost. Customers must also ensure that the frequency characteristic of their antenna matches that of the antenna used for approval. As antennae are tuned for their frequency band the use of a different antenna technology may result in a change in emissions outside the 2.4GHz band. It is the customer's responsibility to ensure that an external antenna does not negate the approval.

U.FL connectors are supplied from a number of connector manufacturers. Details of Hirose's mating U.FL connectors are available at http://www.hirose.co.jp/cataloge_hp/e32119372.pdf

9.3 Power Supply Considerations

The power supply for the Module must be a single voltage source within the range of 3.3 V to 5.0 V. It must be able to provide sufficient current for a transmit burst. This can rise to 550mA.

The Module includes on-board regulators to provide local 3.0V. This rail is accessible on pin 27 for monitoring purposes only. Under no circumstances should this pin be used to source current.

Power (VCC_5V) is provided via the board-to-board connector Pins 28, 29 and 31. All VCC_5V and GND pins should be connected to ensure that individual pin current capacities are not exceeded during transmit current peaks.

9.4 Power-On-Reset

The Module is provided with an active high reset pin (Hirose 40way DF12C connector pin 13). However, on the application of power, the Power On Reset circuit built into the Module will ensure that the unit starts correctly. The external reset signal allows the module to be reset under software control from the host. After a power on or reset operation, the module will de-assert the UART_RTS output and re-assert it when it is ready to receive commands.

9.5 Operational Temperature

The Wireless LAN module is designed to meet an operational temperature of -40°C to +85°C in normal operation where it is running in IEEE power save mode.

If the module is run in a mode that results in more frequent receive and transmit activity the operating temperature will need to be derated to ensure that overall module power dissipation limits are not exceeded. When the ambient temperature rises above 60°C the module should only be operated in powersave mode 1 or higher.

The Wireless LAN module can operate in temperatures as low as -40°C, but the cold start minimum temperature must not be below -25°C.

9.6 Board to board connector and stacking height

The WISM connects to a motherboard by means of a board-to-board connector that is supplied by Hirose. Mating headers from Hirose are available in different stacking heights, allowing the spacing between the WISM module and carrier pcb to be changed from 3.5mm to 5.0mm.

Item	Part number	Stacking height	HRS number
Receptacle on Module	DF12C-40DS-0.5V(86)	3.5 mm – 5 mm	CL537-0007-7-86
Headers DF12 series	DF12(3.5)-40DP-0.5V(86)	3.5 mm	CL537-0032-4-86
	DF12(4.0)-40DP-0.5V(86)	4.0 mm	CL537-0057-5-86
	DF12(5.0)-40DP-0.5V(86)	5.0 mm	CL537-0157-0-86

Notes: The headers listed above are with boss and metal fitting.
Suffix -86 denotes RoHS compliance.

9.7 Hirose Connector general specification

Parameter	Specification (40 pin Board to Board connector)
Number of Contacts	40
Quantity delivered	2000 Connectors per Tape & Reel
Voltage	50V
Current Rating	0.5A max per contact
Resistance	0.05 Ohm per contact
Dielectric Withstanding Voltage	500V RMS min
Operating Temperature	-45°C to +125°C
Contact Material	phosphor bronze (surface: gold plated)
Insulator	Material PA , beige natural
Stacking height	3.0 mm ; 3.5 mm ; 4.0 mm ; 5.0 mm
Insertion force	21.8N
Withdrawal force 1st to 50th	10N
Maximum connection cycles	50

See http://www.hirose.co.jp/cataloge_hp/e53700036.pdf for detail information on the PCB socket.

9.8 Mounting the Module onto the application platform

There are many ways to properly install the Module in the host device. An efficient approach is to mount the PCB to a frame, plate, rack or chassis. Fasteners can be M1.8 or M2 screws plus suitable washers, circuit board spacers, or customized screws, clamps, or brackets in 2.2mm diameter holes. Note that care should be taken to ensure the head of the fixing does not interfere with the circuit. Nylon fixings are recommended.

The antenna (Brown square component on top side of PCB) must not be influenced by any other PCBs, components or by the housing of the host device. The proximity of the antenna to large metallic objects can affect the range and performance of the system. Designers should carefully consider the location of the Module and the type of enclosure material that is used.

To prevent mechanical damage, be careful not to force, bend or twist the Module. Be sure it is positioned flat against the host device.

9.8.1 Fixing Pillars

EZURiO in conjunction with Richco has designed a mounting pillar for use with the Wireless LAN Module. This allows the module to be securely held to a primary pcb using snap fit details. A variety of heights are available to accommodate different variants of Hirose stacked connectors. Pillars supporting a 3.5mm stacked board height can be supplied by EZURiO. These and alternative spacings can also be ordered directly from Richco.

Customer designs using these pillars should use 2.5mm diameter holes on a 1.6mm thick PCB.

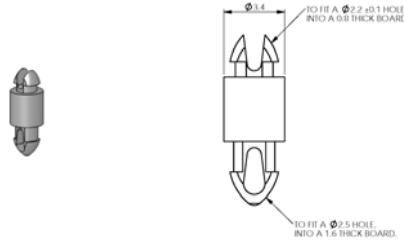

Board Spacing	Part number	Source	Matching HRS PCB Socket
3.6 mm	NPR2005-153-3.6	EZURiO / Richco	CL537-0032-4-86
4.1 mm	NPR2005-153-4.1	Richco	CL537-0057-5-86
5.1 mm	NPR2005-153-5.1	Richco	CL537-0157-0-86

9.9 Labelling

The label contains the Part number, firmware version loaded at manufacture, serial number and statutory approvals information.

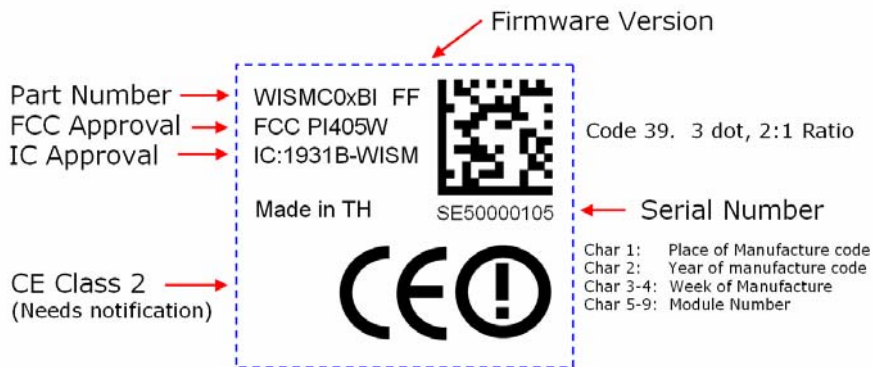

9.10 Ordering Information

The WISM described in this data sheet should be ordered using the part number below:

Part Number	Description
WISMC01BI	802.11b/g Wireless LAN Processor Module

10. Qualification

10.1 Qualification Process

The following safety precautions must be observed during all phases of the operation, usage, service or repair of any application incorporating this Module. Manufacturers of the RF equipment are advised to convey the following safety information to users and operating personnel and to incorporate these guidelines into all manuals supplied with the product. Failure to comply with these precautions violates safety standards of design, manufacture and intended use of the product. EZURiO assumes no liability for customer failure to comply with these precautions.

10.2 Safety Information:

If the WLAN module is used in equipment that might be taken and operated on a commercial flight, the following safety instructions, or similar warning should be added to the user manual.

“Switch off the Wireless device before boarding an aircraft. Make sure it cannot be switched on inadvertently. The operation of wireless appliances in an aircraft is forbidden by many airlines to prevent interference with communications systems.”

10.3 Certifications

10.3.1 FCC and Industry Canada Statements

This device complies with part 15 of the FCC Rules. Operation is subject to the following two conditions: (1) This device may not cause harmful interference, and (2) this device must accept any interference received, including interference that may cause undesired operation.

Changes or modifications not expressly approved by the party responsible for compliance could void the user's authority to operate the equipment.

To inherit the modular approval, the antennas for this transmitter must be installed to provide a separation distance of at least 20 cm from all persons and must not be co-located or operating in conjunction with any other antenna or transmitter.

Co-location with other radio transmitting devices operating concurrently in the same band will require additional testing and certification.

Designers should note the distinction that the FCC makes regarding portable and mobile devices. Mobile devices are defined as products that are not used closer than 20cm to the human body, whereas portable devices can be used closer than 20cm to the body. In the case where the WISM module is used in a portable device, additional SAR testing must be performed on the complete product.

10.3.1.1 FCC Labelling requirement

If the FCC ID is not visible when the module is installed inside another device, then the outside of the device into which the module is installed must also display a label referring to the enclosed module. This exterior label can use wording such as the following: “Contains Transmitter Module FCC ID: PI405W” or “Contains FCC ID: PI405W.” Any similar wording that expresses the same meaning may be used.

10.3.2 National RF approvals

A list of the countries where the Module is approved will be provided by EZURiO as required. As a minimum the product is listed in Europe, Scandinavia, Canada and USA. EZURiO assumes no liability for customer failure to comply with national RF approval.

10.3.2.1 R&TTE Notification Requirement

The 2.4GHz band has some restrictions within the EU when the transmit power level is greater than 10mW (R&TTE Class 2). Because of this, it is designated within R&TTE as a non-harmonised band. Such products must be notified to the appropriate Notified Body within each country where it is placed on the market. EZURiO has notified the WISM module, but manufacturers incorporating it within their products and intending to sell these within Europe have a responsibility to notify the appropriate nominated body before commercial introduction. A list of nominated bodies is available at:

http://eur-lex.europa.eu/LexUriServ/site/en/oj/2003/c_302/c_30220031212en00010414.pdf

Further details on the notification procedure are given in EZURiO's Application Note AN016 - Notification Requirements for Wireless Products.

11. Related Documents

AN008 - Wireless Development Kit User Guide

AN013 – WISM – A complete wireless processor

AN016 - Notification Requirements for Wireless Products

WHP-050004-1V0 Bluetooth and 802.11 Coexistence

UWTerminal User Guide

UWScript Core Language Manual

UWScript Wireless Extensions Manual

UWScript Wireless LAN Web server

Documents are available for download from www.ezurio.com

12. Development Kit

EZURiO offers a Wireless Development Kit for embedded developers which is unique in supporting Bluetooth, 802.11 and GSM/GPRS. It provides a simple design environment that can dramatically reduce the development time of wirelessly enabled products.

The Wireless Development Kit is available with EZURiO's pre-qualified Bluetooth and 802.11 Wireless LAN modules and accepts both 40 pin and 50 pin versions of these modules.

EZURiO's modules contain embedded protocol stacks, removing the need for complex programming on a host processor.

Features:

Bluetooth

- Complete, qualified Bluetooth stack
- Support for Version 2.0
- Upgradeable for Bluetooth 2.1 when available
- Simple AT style programming interface
- Audio codec evaluation kits available

802.11b/g

- Enhanced drivers for low power operation
- Robust TCP/IP stack or UDP/SLIP
- Integrated Web Server (TCP/IP version only)
- Embedded interpreter (UWScript) for fast development (TCP/IP version only)

A range of codec audio development boards for Bluetooth voice applications are available. These can be plugged into the wireless development kit for rapid of audio applications.

For cellular applications, the Wireless Development Kit also supports Siemens' MC55 range of GSM/GPRS modules, which are pin compatible with EZURiO's wireless LAN module. This permits designers to develop products which can support either short range or wide area wireless connectivity, with incredibly fast time to market.

13. Interchangeable Bluetooth Module

EZURiO's range of Wireless LAN modules have been designed to be physically interchangeable with the BTM402 Bluetooth module and the BISM Bluetooth Serial Module. For product designers this means that they can design a single pcb, which can be populated with either an 802.11 or Bluetooth module, giving the opportunity to launch two different variants of wireless connectivity at minimal additional engineering effort.

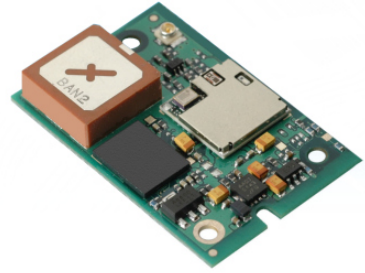

The BISM range of Bluetooth modules are fully integrated and qualified products, featuring an embedded Bluetooth stack and a comprehensive set of AT commands for managing the wireless link.

They are ideal for low power M2M applications where cable replacement is the primary requirement. They also feature PCM support for voice applications, including eSCO operation. The BISM2 PA module is the industry's most efficient long range Bluetooth module, with open field ranges in excess of 1km.

14. Disclaimers

EZURiO'S WIRELESS PRODUCTS ARE NOT AUTHORISED FOR USE AS CRITICAL COMPONENTS IN LIFE SUPPORT DEVICES OR SYSTEMS WITHOUT THE EXPRESS WRITTEN APPROVAL OF THE MANAGING DIRECTOR OF EZURiO LTD.

The definitions used herein are:

a) Life support devices or systems are devices which (1) are intended for surgical implant into the body, or (2) support or sustain life and whose failure to perform when properly used in accordance with the instructions for use provided in the labelling can reasonably be expected to result in a significant injury to the user.

b) A critical component is any component of a life support device or system whose failure to perform can be reasonably expected to cause the failure of the life support device or system, or to affect its safety or effectiveness.

EZURiO does not assume responsibility for use of any of the circuitry described, no circuit patent licenses are implied and EZURiO reserves the right at any time to change without notice said circuitry and specifications.

14.1 Data Sheet Status

EZURiO Ltd reserve the right to change the specification without prior notice in order to improve the design and supply the best possible product. Updated information, firmware and release notes will be made available on www.ezurio.com.

Please check with EZURiO Ltd for the most recent data before initiating or completing a design.